

VB130

Conference Camera

User Manual



FEDERAL COMMUNICATIONS COMMISSION

NOTE: This equipment has been tested and found to comply with the limits for a Class A digital device, pursuant to part 15 of the FCC Rules. These limits are designed to provide reasonable protection against harmful interference when the equipment is operated in a commercial environment. This equipment generates, uses, and can radiate radiofrequency energy and, if not installed and used in accordance with the instruction manual, may cause harmful interference to radio communications. Operation of this equipment in a residential area is likely to cause harmful interference in which case the user will be required to correct the interference at his own expense.

FCC Caution: Any changes or modifications not expressly approved by the party responsible for compliance could void the user's authority to operate this equipment.

This device complies with part 15 of the FCC Rules.

Operation is subject to the following two conditions:

- (1) This device may not cause harmful interference, and
- (2) this device must accept any interference received, including interference that may cause undesired operation.

Warning:

This is a class A product. In a domestic environment this product may cause radio interference in which case the user may be required to take adequate measures.

This Class A digital apparatus complies with Canadian ICES-003. Cet appareil numérique de la classe A est conforme à la norme NMB-003 du Canada.

DISCLAIMER

No warranty or representation, either expressed or implied, is made with respect to the contents of this documentation, its quality, performance, merchantability, or fitness for a particular purpose. Information presented in this documentation has been carefully checked for reliability; however, no responsibility is assumed for inaccuracies. The information contained in this documentation is subject to change without notice.

In no event will AVer Information Inc. be liable for direct, indirect, special, incidental, or consequential damages arising out of the use or inability to use this product or documentation, even if advised of the possibility of such damages.

TRADEMARKS

"AVer" is a trademark owned by AVer Information Inc. Other trademarks used herein for description purpose only belong to each of their companies.

COPYRIGHT

©2021 AVer Information Inc. All rights reserved.

All rights of this object belong to AVer Information Inc. Reproduced or transmitted in any form or by any means without the prior written permission of AVer Information Inc. is prohibited. All information or specifications are subject to change without prior notice.

NOTICE

SPECIFICATIONS ARE SUBJECT TO CHANGE WITHOUT PRIOR NOTICE. THE INFORMATION CONTAINED HEREIN IS TO BE CONSIDERED FOR REFERENCE ONLY.

CAUTION

- Risk of explosion if battery is replaced by an incorrect type.
- Dispose of used batteries in a safe and proper manner.

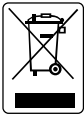

THE MARK OF CROSSED-OUT WHEELED BIN INDICATES THAT THIS PRODUCT MUST NOT BE DISPOSED OF WITH YOUR OTHER HOUSEHOLD WASTE. INSTEAD, YOU NEED TO DISPOSE OF THE WASTE EQUIPMENT BY HANDING IT OVER TO A DESIGNATED COLLECTION POINT FOR THE RECYCLING OF WASTE ELECTRICAL AND ELECTRONIC EQUIPMENT. FOR MORE INFORMATION ABOUT WHERE TO DROP OFF YOUR WASTE EQUIPMENT FOR RECYCLING, PLEASE CONTACT YOUR HOUSEHOLD WASTE DISPOSAL SERVICE OR THE SHOP WHERE YOU PURCHASED THE PRODUCT.

WARNING

- To reduce risk of fire or electric shock, do not expose this appliance to rain or moisture. Warranty will be void if any unauthorized modifications are done to the product.
- Do not drop the camera or subject it to physical shock.
- Use correct power supply voltage to avoid damaging camera.
- Do not place the camera where the cord can be stepped on as this may result in fraying or damage to the lead or the plug.
- Hold the bottom of the camera with both hands to move the camera. Do not grab the lens or lens holder to move the camera.

Remote Control Battery Safety Information

- Store batteries in a cool and dry place.
- Do not throw away used batteries in the trash. Properly dispose used batteries through specially approved disposal methods.
- Remove the batteries if they are not in use for long periods of time. Battery leakage and corrosion can damage the remote control. Dispose of batteries safely and through approved disposal methods.
- Do not use old batteries with new batteries.
- Do not mix and use different types of batteries: alkaline, standard (carbon-zinc) or rechargeable (nickel-cadmium).
- Do not dispose of batteries in a fire.
- Do not attempt to short circuit the battery terminals.

MORE HELP

For FAQs, technical support, software and user manual download, please visit:

Global: <https://www.aver.com/download-center>

USA: <https://www.averusa.com/business/support/>

Europe: <https://www.avereurope.com/download-center/>

Technical Support:

Global: <https://aver.com/technical-support>

USA: <https://averusa.force.com/support/s/contactsupport>

Europe: <https://www.avereurope.com/technical-support/>

Contact Information

Global

AVer Information Inc.
<https://www.aver.com>
8F, No.157, Da-An Rd.,
Tucheng Dist.,
New Taipei City 23673,
Taiwan
Tel: +886 (2) 2269 8535

USA

AVer Information Inc.
<https://www.averusa.com>
668 Mission Ct.,
Fremont, CA 94539
Tel: +1 (408) 263 3828
Toll-free: +1 (877) 528 7824
Technical support:
support.usa@aver.com

European Headquarters

AVer Information Europe B.V.
<https://www.avereurope.com>
Westblaak 140, 3012KM,
Rotterdam, Netherlands
Tel: +31 (0) 10 7600 550
Technical support:
eu.rma@aver.com







Contents

Package Contents.....	1
Optional Accessories.....	1
Product Introduction.....	2
Overview	2
LED Indicator.....	3
Tilt via Screen Mount Kit	3
Wall Mount Installation	4
How to Control Fill Light.....	6
Control Fill Light via Device Buttons	6
Control Fill Light via Remote Control.....	6
Remote Control	7
Installation.....	11
Device Connection	11
Wireless Dongle Installation.....	12
Ethernet Connection.....	13
Expansion Microphone Installation (Optional).....	13
Operating the Camera	14
Make a Video Call	14
Make a Connection through the Browser.....	14
Web Settings	18
First Time Login.....	18
Live Screen Operation	19
Set up the Preset.....	20
Select the Preset Position	21
Camera Settings.....	21
Tracking Mode	22

Framing Speed.....	23
Audio Fence Mode.....	24
Home Position.....	24
On Screen Menu.....	24
Save Preset	25
Fill Light.....	25
Image Settings	26
Field of View	26
Image Flip	26
Image Mirror.....	26
True WDR	26
Frequency	27
White Balance.....	27
Noise Reduction.....	27
Brightness	27
Sharpness.....	27
Saturation.....	27
Low Light Compensation	28
Video Format Settings.....	29
H.264 Profile	29
IP Stream Resolution	29
Frame Rate.....	29
Bit Rate	30
RTSP.....	30
RTMP	31
Network Settings	32
RJ45.....	32
System Settings	33
Language	33

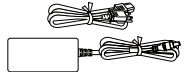
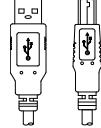
Firmware Update	33
Factory Default.....	34
Camera Reboot.....	34
Change Password.....	35
SSL Certificate	36
Date Format.....	36
Time Format.....	36
Time Correction Mode	37
Information	38
Audio Settings	39
Noise Suppression.....	39
Beamforming Microphone.....	39
Echo Cancellation	40
Keyboard Noise Suppression	40
PTZApp 2	41
Install PTZApp 2.....	41
Use PTZApp 2 with USB Devices	41
EZLive	49
Use AVer EZLive	49

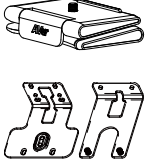



Package Contents

VB130 Unit & Lens Cover	Remote Control	Power Adaptor & Power Cord*	USB 2.0 Type-B to Type-A Cable (5m)
			
USB Type-A to Type-C Adapter	Screen Mount Kit or Wall Mount Kit**	Tripod Screw	QR Code Card
			

*The power cord will vary depending on the standard power outlet of the country where it is sold.

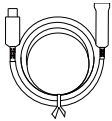
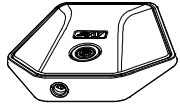
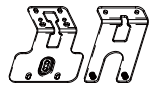
**Depending on different regions, it may include screen mount or wall mount kit in the package.

Optional Accessories

USB 3.1 Extender 10m/20m/30m	Micro B Expansion Microphone 10m/20m (Cable is included.)	Wall Mount Kit	Wireless Dongle
			
USB 3.1 Type-B to Type-A Cable (3m)	Screen Mount Kit		
			

*Optional Accessories will vary depending on the country where it is sold.

Product Introduction

Overview

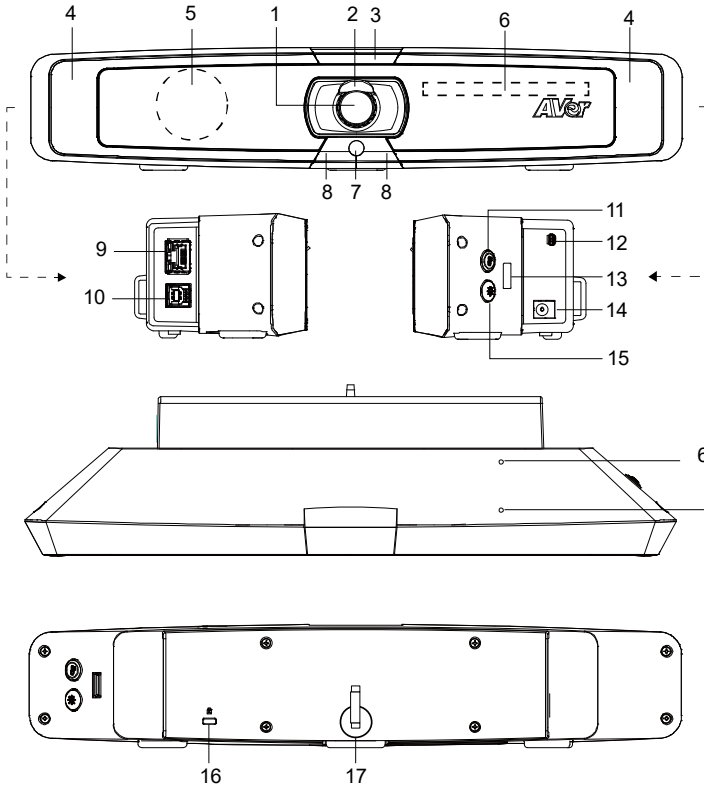

- | | |
|---------------------------|---|
| (1) Lens | (10) USB 3.1 Type-B Port |
| (2) Lens Cover | (11) Color Temperature Button |
| (3) LED Indicator | (12) Mini USB Port for Expansion Microphone |
| (4) Fill Light | (13) USB 2.0 Type-A Port |
| (5) Speaker | (Only for Wireless Dongle*) |
| (6) Microphone Array Area | (14) DC 12V Power Jack |
| (7) Color Sensor | (15) Light Level Button |
| (8) IR Sensor | (16) Kensington Lock |
| (9) Ethernet Port | (17) Velcro Strap |

*Wireless dongle (for Bluetooth connection) is an optional item in certain countries. Please contact your local dealer for purchasing.

LED Indicator

Power on: Blink blue once

Start-up: Solid red

Power on completely but no USB connection: Solid orange

Power and USB cable connected but device is idle or a call on hold: Solid white

Video and audio on: Solid blue

Calling: Fast blink white or blue depending on original status

Video mute and audio on (During a call): Solid purple

Video on and audio mute (During a call): Solid red

A second calling: Fast blink white, blue, or purple depending on original status

Tilt via Screen Mount Kit

1. Open the screen mount and use its tripod screw to secure the VB130. (Depending on different regions, it may include screen mount or wall mount kit in the package.)

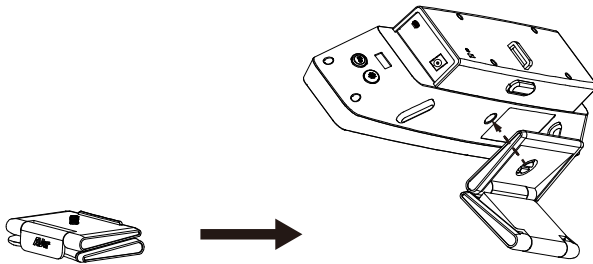

2. Clip the screen mount on the top of TV or the monitor. Tilt the screen mount if needed.

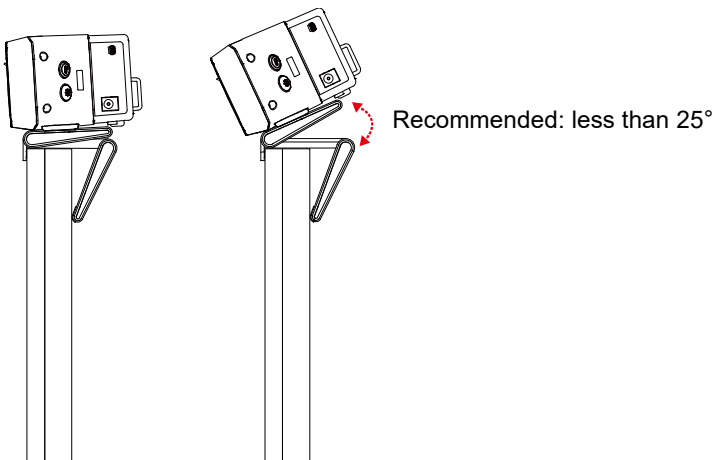

Wall Mount Installation

1. Use the drilling paper in the wall mount kit to drill four holes on the wall where the user wants to mount the camera. (Depending on different regions, it may include screen mount or wall mount kit in the package.)

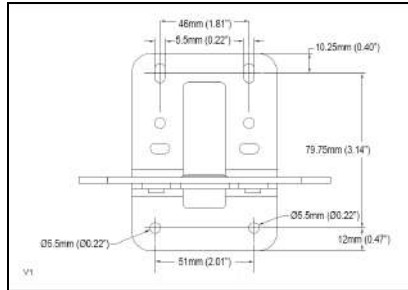

2. Use two M4 x8 screws in the wall mount kit to assemble L-mount brackets.

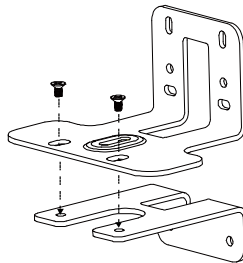

3. Use four screws (not supplied in the wall mount kit) to secure the L-mount brackets on the wall.

[Note]

Screws for Cement wall: M4 x20mm self-tapping screws (x4) + Plastic conical anchor

Screws for Wooden wall: M4 x20mm self-tapping screws (x4)

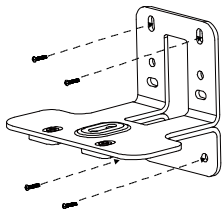

4. Pass the cables through the hole on the L-mount brackets and connect the cables to corresponding connection ports.

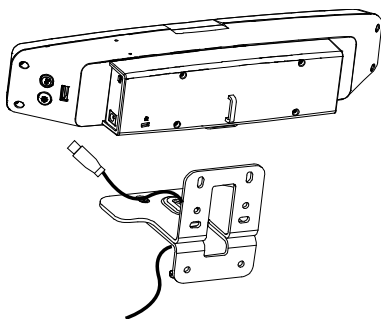



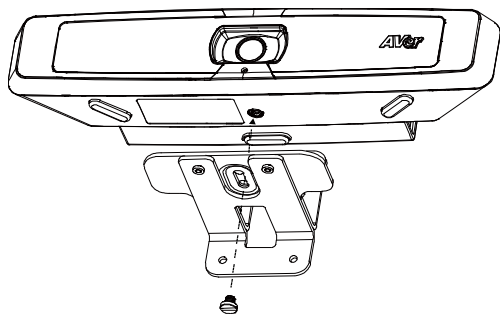

5. Use the tripod screw in the wall mount kit to secure VB130 on the L-mount brackets.

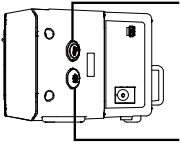

How to Control Fill Light



Control Fill Light via Device Buttons



- Hold either temperature button  or light level button  for 2~3 sec to switch on/off fill light function.
- Hold both temperature button  and light level button  together for 2~3 sec to switch between auto/manual light adjustment. The message below will show on the image screen.

Auto Light

Manual Light



- Whether under auto or manual light adjustment function, user can press the  button to slightly adjust color temperature or press the  button to adjust light level.

[Note] The light brightness level in manual mode is much higher than auto mode. There are 12 levels adjustment in manual light mode.

- The camera can memorize the last setting or back to default. Please do advanced settings of the fill light function via PTZApp 2 or IP web page.
- The color temperature ranges from 2700k to 5700k.

[Note] The fill light function is set at auto mode as factory default. When video streaming is on, the fill light will be on and the lighting level will be automatically adjusted based on actual environment in the meeting room.

Control Fill Light via Remote Control

- Long press either  or  button for 1~2 sec to turn on/off the fill light function.

[Note] While using remote control to turn on fill light, it will be manual light mode.

- When fill light is on, press  or  button to increase/ decrease light level.

Remote Control

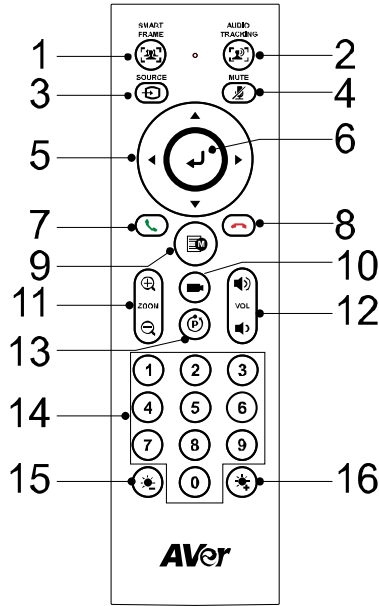

Name	Function
------	----------

1. SmartFrame

One-click automatic FOV adjustment to fit all participants in screen for one time. Press and hold the button for 1~2 sec to switch from manual to auto framing mode or Off.

An icon message (as figure shown) will display on the left upper screen to indicate in SmartFrame status. The icon will appear 2~3 sec on the screen. Once the process is done, it will disappear. If you don't want to see the icon display, please go to PTZApp 2 or Web setting, find "On Screen Menu" function and select "Off".



[Notes]

- SmartFrame deploys face and body detection technology. People wearing masks or in side facial profiles can still be detected. The maximum detection distance is 5 meters.
- Camera will track people while moving. It will start to focus and zoom in when people stop moving anymore for 1~5 seconds, depending on the framing speed you set up in PTZApp 2 or web page. The default framing speed is "Middle" speed. "High" speed is more suitable for one person tracking.

Name	Function
------	----------

2. Audio AI Control

Press and hold the button for 1~2 sec to switch modes among Audio tracking, Audio frame, Audio preset tracking, Presentation mode, Audio fence and Off.

An icon message (as figure shown) will display on the left upper screen to indicate in Audio AI status. If you don't want to see the icon display, please go to PTZApp 2 or Web setting, find **"On Screen Menu"** function and select **"Off"**.



: Audio tracking, audio frame, audio preset tracking, and presentation mode



: Audio fence

[Notes]

- ✓ **Audio tracking:** Camera pans/tilts (ePTZ) until speaker is centered before zooming in. The camera moving path will be shown in the screen. Audio tracking supports up to 4~5m distance away from the camera.
- ✓ **Audio frame:** Once detecting human sound, camera focuses on speaker, shows the speaker in view, and zooms in without showing moving path in the screen.
- ✓ **Audio preset tracking:** Set up preset points in advance and choose this mode. After detecting human sound, camera will track the specific area without zooming in on the person. Make sure there is no overlap between two preset areas.
- ✓ **Presentation mode:** This is a combination function of preset tracking and audio tracking. Please set up a presentation area in the PTZApp 2, IP web page, or remote control first. For example, select the whole white board as presentation area. When someone speaks within this area, camera shoots this area. When someone speaks outside of this area, camera will track this person in view and zoom in. If there is no more sound and no person's face is detected outside of this area in 3 minutes, the camera will shoot on the presentation area again.



- ✓ **Audio fence:** Microphone only picks up the sound within viewing angle. Adjust the camera viewing area via PTZApp 2 or IP web page to silence the sound beyond the meeting area.



[Note] All the AI tracking functions, pan, tilt, and zoom in/out will be disabled while audio fence is on.

3. Bluetooth

- ✓ Hold it for 1~2 sec to enable Bluetooth pairing with mobile phone.
- ✓ Short press it again to disconnect Bluetooth.

[Note] Wireless dongle is an optional item. Please contact your local dealer for purchasing.

4. Mute/Unmute

Mute/Unmute the speakerphone.

5. Camera Directional Control

Use the directional button on the remote to control the direction of the camera. Press the directional button to move the camera or press and hold for continuous pan or tilt.

6. Enter

Press to show the current AI function on screen such as Auto Framing.

7. Call/Answer

Answer a call or start a call.

8. End Call

End the call.

9. OSD Menu

Not supported.

10. Load Preset Hotkey

Press to move to preset position as user has set in sequence.

11. Zoom In/Zoom Out

Increase/Decrease the camera zoom.

12. Volume Up/Down



Adjust volume up or down.

13. Compound Key

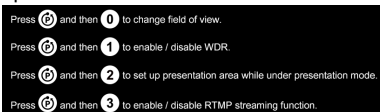
- When pressing this button, the following photo will show up. Then press the corresponding number key for setting up specific function.





- **FOV:** Press then to change field of view.
- **WDR:** Press then to enable/disable the WDR function.
- **Presentation mode:** After using the directional and zoom in/out button on the remote to select an area, press then to save presentation area.

-
- **RTMP:** Press  then  to enable/disable the RTMP streaming function.
-



14. Number Buttons/Preset Position

- Long press the number button to set the preset point.
 - One-click the number button to load the preset point.
-

15. Brightness -

- Long press either  or  button for 1~2 sec to turn on/off the fill light function.
 - When fill light is off, press this button to decrease image brightness.
 - When fill light is on, press this button to decrease light level.
-

16. Brightness +

- Long press either  or  button for 1~2 sec to turn on/off the fill light function.
 - When fill light is off, press this button to increase image brightness.
 - When fill light is on, press this button to increase light level.
-

Installation

Device Connection

Connect VB130 to PC/laptop with provided USB 2.0* cable and connect the power cord of VB130 to power wall outlet.

[Note] Use the supplied Velcro strap to secure and manage the cable.

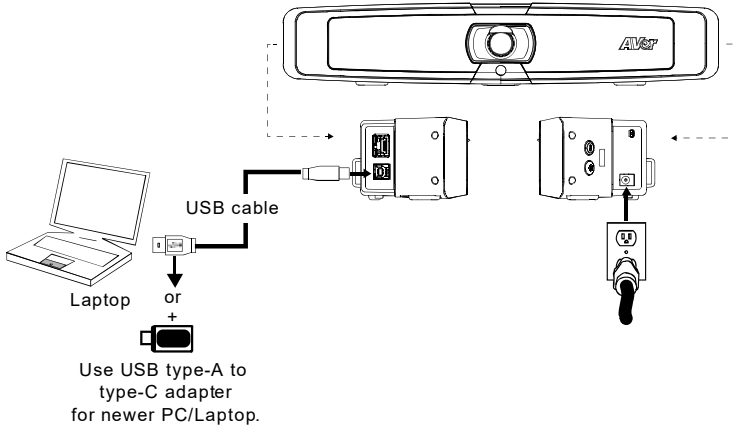

*Resolution & frame rate for USB 2.0 and USB 3.1 connection:

USB 2.0		USB 3.1	
YUV	M-JPEG	YUV	M-JPEG
- 640x480 or less resolution, up to 30fps	- Up to 4k/30fps - 1080p/60fps	- Up to 1080p/30fps - 720p/60fps	- Up to 4k/30fps - 1080p/60fps

■ Digital zoom ratio vs video resolution

Resolution	Zoom in/out ratio
4K	N/A
1080p/60fps	2x
Others	4x

Since SmartFrame function requires zoom function, it will not work under 4K resolution.

Wireless Dongle Installation

Use VB130 as mobile phone's external audio device:

When using mobile phone to have a video call, user can connect their mobile phone to VB130 via Bluetooth wireless connection to enjoy crystal clear audio quality.

Plug the wireless dongle into the USB 2.0 type-A port. Use remote control or PTZApp 2 to enable Bluetooth function. Enable Bluetooth of mobile phones to find VB130 and connect it to use VB130 as external microphone and speaker during a conference meeting.

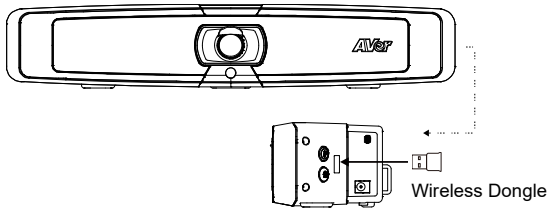

Make a three-way call:

While having a video call such as Zoom or Teams, user can use mobile phone to call third party to instantly join the on-going meeting. Connect a mobile phone to VB130 via Bluetooth connection. Use the mobile phone to call third party and the third party's sound can be heard by remote site to start a three-way conference call.

[Note] The wireless dongle is an optional item in certain countries.

Ethernet Connection

VB130 supports ethernet connection which allows user to access VB130 from remote site through browser. Web accessing please refer to [“Make a Connection through the Browser”](#).

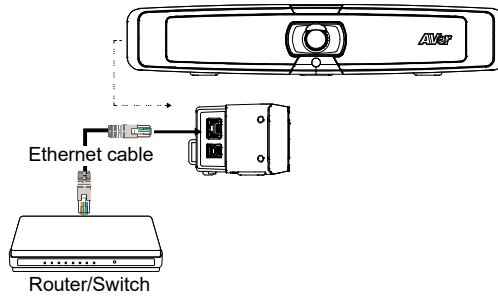

Expansion Microphone Installation (Optional)

User can purchase the expansion microphone from AVer.

The expansion microphone can expand the sound received and controlled of audio, mute and unmute.

[Note] Cable is included with optional expansion microphone. There are two lengths of cables - 10m and 20m.

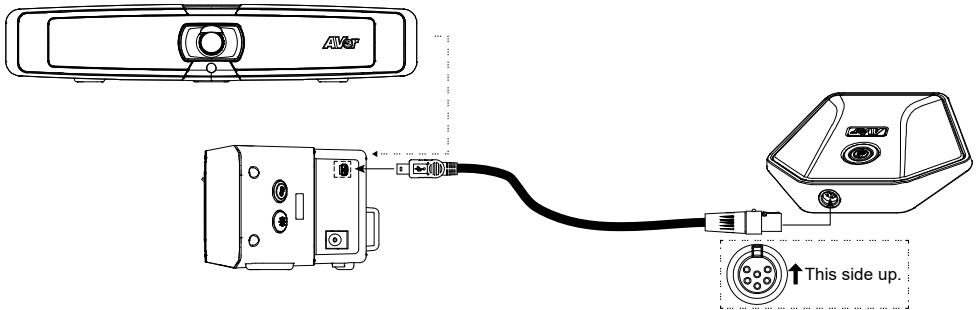

Operating the Camera

Make a Video Call

1. Make sure all devices (VB130, laptop/PC, TV/monitor) are well connected and powered on.
2. Run your video application (Teams, Skype™, Skype for Business, Google Hangouts™, Zoom™, WebEx™, Adobe Connect™, WebRTC, etc.) on your laptop/PC.
3. Set the VB130 camera as the primary camera and speakerphone for your video application (refer to your video application user guide). You can now make your call.

[Note] The VB130 is a plug-and-play conference camera. The system requires no special drivers, but we do recommend installing the PTZApp 2 for a better user experience. For information on how to install and use the PTZApp 2, refer to the PTZApp 2 section in this user manual.

Make a Connection through the Browser

VB130 has an Ethernet port for IP streaming and allows administrators to remotely control and set up the camera via an internet access. Moreover, VB130 also supports RTSP and RTMP functions. For more details, please refer to page 30~31 or contact our technical support. When USB streaming is on, RTSP/RTMP functions will not work simultaneously.

1. Make sure the VB130 has an internet access connection.
2. Launch PTZApp 2* () and connect VB130 to PC with USB cable. The camera default IP address is **192.168.1.168**.



[Note] The browser supports:

- Chrome: version 76.x or above
- Firefox: version 69 or above
- IE: Doesn't support

3. Click pencil icon (✎) to edit IP address**.

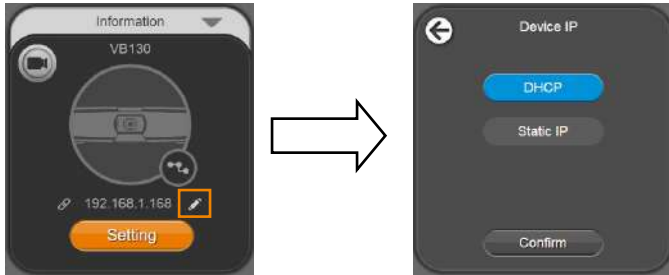

4. Click weblink icon (🔗) to launch Chrome page. Please enter the password (default password is **aver4321**). User will be asked to set a new account and password. (Please enter PTZApp 2 to reset password back to default while password is forgotten.)



5. After editing IP address, user can access web settings of the camera with only Ethernet cable connection. Unplug the USB cable.

6. The main web screen is displayed as below.



* For information on how to install and use the PTZApp 2, refer to the PTZApp 2 section in this user manual.

** To support IP address changes in groups, user can download AVer IP Finder app.

1. Download the IP Finder from <https://www.aver.com/download-center> (Global & European Headquarters) or <https://www.averusa.com/business/support/> (USA).
2. Run the IP Finder.
3. Click "**Search**", and all available devices will be listed on the screen.
4. Select a camera from the list. The corresponding fields of IP address will display.
5. To change the IP address of camera, user can select "**DHCP**" or "**Static IP**".

The DHCP should get the IP address from local dynamic IP sever. The static IP, user can enter the specific IP address. Click "**Apply**" to apply the setting to the camera. The password is required (default password is **aver4321**).

6. Click "**Search**" button to re-scan the camera.
7. Double-click on the IP address of camera from the list to connect to camera through the browser.
8. Enter the default password (**aver4321**) to log in to Web setup screen.

Web Settings

VB130 supports Ethernet connection; users can enter the IP address into the web browser to connect to the camera for detail settings.

First Time Login

To find the IP address of the camera; please refer to “**Make a Connection through the Browser**” section.

1. Open the browser on your laptop/PC and enter the IP address of the camera.
2. Enter the password at login screen. The default password is “**aver4321**”.
3. The main web screen is displayed.



Live Screen Operation

User can control the camera direction, zoom in/out, and set preset position.

[Note]

1. The system will force the previous login to log out, when there is a second login.
If the web page is idle without any request for more than 4 hours, user will be logged out.
2. The resolution of live screen is 848x480/ 10fps.

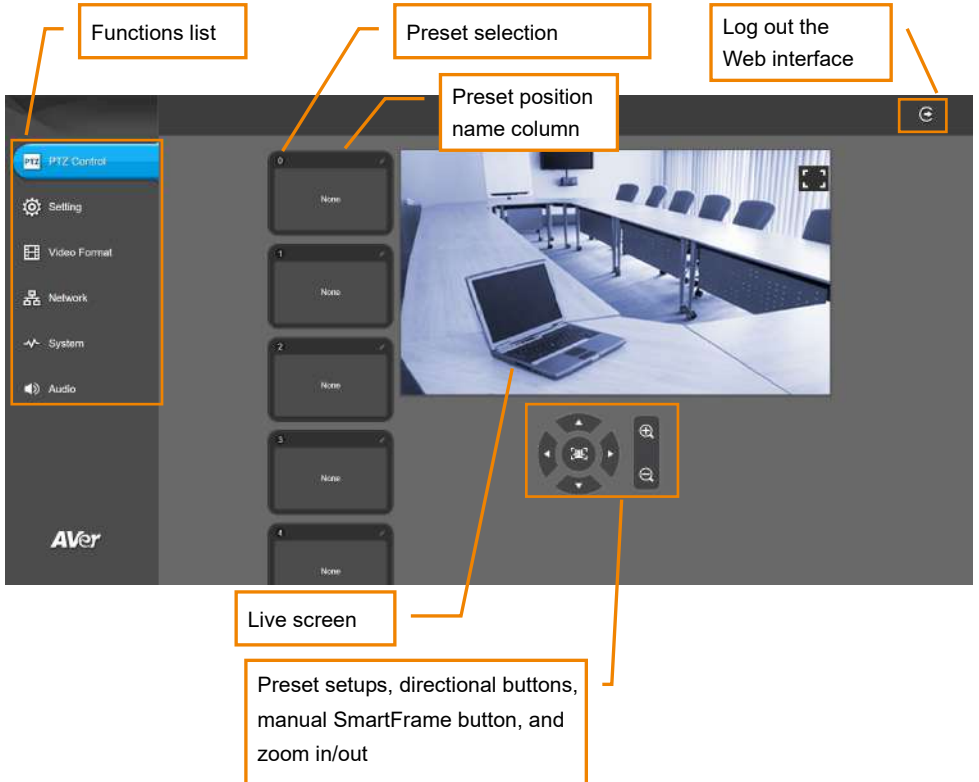

Set up the Preset

User can set 10 preset positions.

1. In live screen, use mouse to scroll up or down and click the preset number frame (0~9).
2. Use ▲, ▼, ◀, ▶ and zoom in/out buttons to adjust the camera screen view to desired position.
3. Select **Set Preset** button to save the preset. The system will capture the preset screen view and display in preset number frame.



4. Select  icon to edit name of preset frame. Click other Web interface to save the name edited.

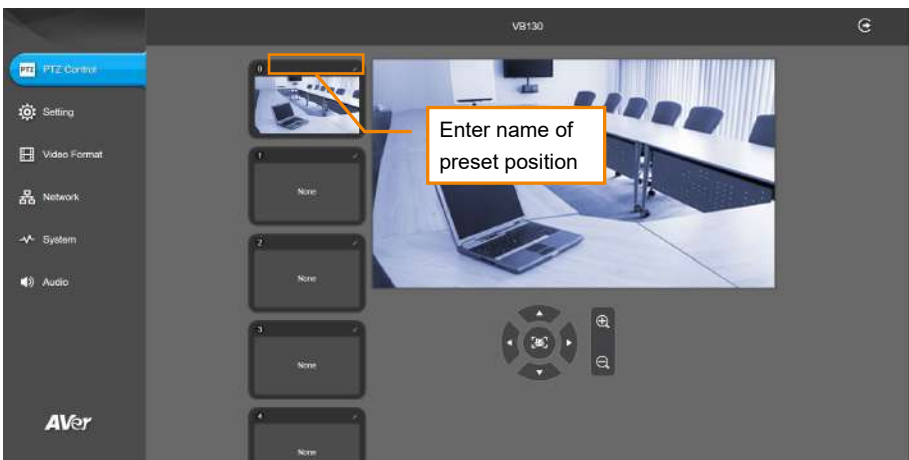

5. To set another preset, repeat the above steps.

Select the Preset Position

Preset positions need to be set.

Use mouse to scroll up or down to select the preset. The live screen will move to the preset screen view.



Camera Settings

The video  icon is to turn on camera live view while doing any settings.

IP icon shows the IP address of the camera.

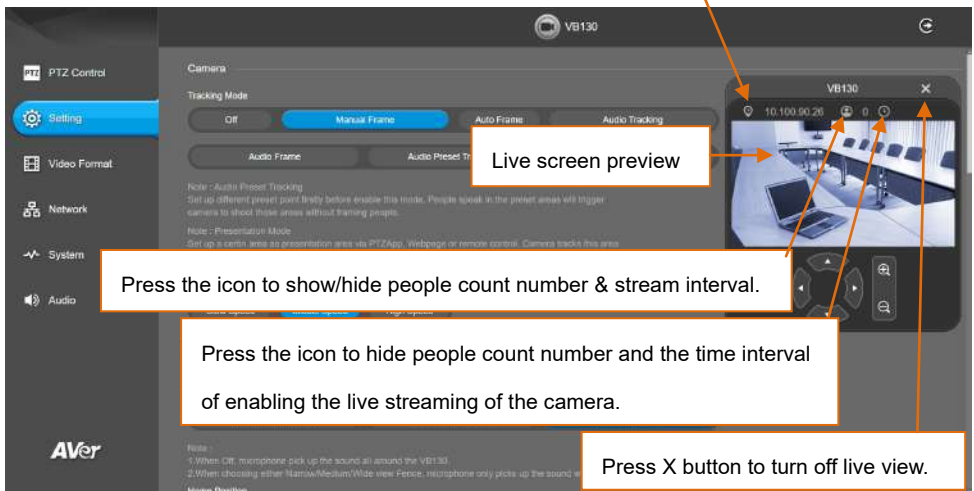

Tracking Mode

Select **Setting > Camera > Tracking Mode > Off, Manual Frame, Auto Frame, Audio Tracking, Audio Frame, Audio Preset Tracking, or Presentation Mode.**

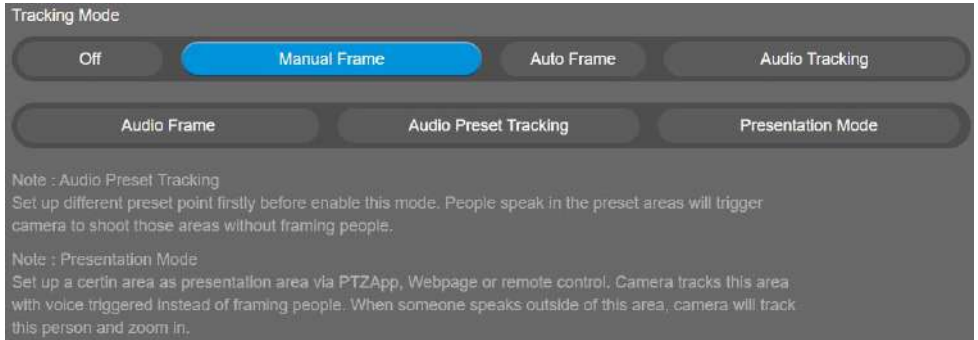

- **Off:** Tracking mode is disabled.
- **Manual Frame:** User one-click SmartFrame button and camera will adjust view angle to fit all participants in screen for once.
- **Auto Frame:** Camera automatically adjusts view angle to frame all participants on screen every time it detects participants' faces or bodies. This action will be activated once people in the room sit or stand still for 1~5 seconds, depending on the framing speed you select.* Once all the participants are in frame, the camera will keep the image stable by not completing any action until



subjects move in or out of the screen. When a participant touches the sides of the screen or enter the 120 degree lens field of view, it will trigger the camera and automatically track, detect, and frame all the participants again.

*The default framing speed is "Middle" speed. "High" speed

is more suitable for one person tracking.



[Note]

VB130 frames people in masks or any facial profile up to 5 meters away!

- **Audio Tracking:** After detecting the sound, camera focuses at the speaker and zooms in. The camera moving path will be shown in the screen.
- **Audio Frame:** Once detecting human sound, camera focuses on speaker, shows the speaker in

view, and zooms in without showing moving path in the screen.

- **Audio Preset Tracking:** Set up preset points in advance before enabling this mode. Once detecting human sound, camera will track the specific area but not zoom in the person. (Only for Preset points 1~9. Preset 0 is for home position).
- **Presentation Mode:** This is a combination of preset tracking and audio frame. First, set up a presentation area for tracking. For example, select the whole white board as presentation area. **Click Edit button.** Use ◀, ▼ ▲, ▶, and zoom in/out button to adjust presentation area. Click **Save** to confirm the setting. When a person talks in this area, camera will immediately shoot this area. When someone speaks outside of this area, camera will move to frame him. When there is no human sound and no people's face or body being detected for more than 3 mins, the camera will shoot back to this area.



You can also use remote control by pressing **(P)** and then **(2)** to save presentation area. After adjusting the desired image proportion and position, press **(P)** then **(2)** to confirm the presentation area. Please notice that this area is beyond 0~9 preset points on remote control.

Framing Speed

Select **Setting > Camera > Framing Speed > Slow Speed, Middle Speed** (default), or **High Speed**. When in auto framing or preset framing mode, camera will automatically frame people if they stand still without moving for 1~5 seconds.

- **Slow Speed:** camera starts to frame people if they don't move for 5 seconds.
- **Middle Speed:** camera starts to frame people if they don't move for 3 seconds.
- **High Speed:** camera starts to frame people if they don't move for 1 second.

[Note] High Speed is more suitable for one person tracking.

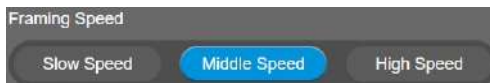

Audio Fence Mode

Select **Setting > Camera > Audio Fence > On**.

Select **Setting > Camera > Audio Fence Mode > Narrow View Fence, Medium View Fence, or Wide View Fence**.



Microphone only picks up the sound within viewing angle. Choose a suitable camera viewing area to silence the sound beyond the meeting area.

[Note] All the AI tracking functions, pan, tilt, and zoom in/out will be disabled while audio fence is on.



Home Position

Every time when powering on the camera, it will turn to this position.

Select **Setting > Camera > Home Position > Last Operating Position, Factory Center Position, or Preset 0**.



On Screen Menu

Enable/disable on screen display status information.

Select **Setting > Camera > On Screen Menu > Off, On, or Load Preset Off**.



Save Preset

Enable/disable “save preset” function. When applicable, IT personnel can limit end-user access to change preset points by locking “save preset” function and switching this function off.

When off, user can't save preset points via IR remote, Hot key, VISCA, web page and PTZApp 2.

Select **Setting > Camera > Save Preset > Off** or **On**.



Fill Light

Select **Setting > Camera > Fill Light > Intelligent Lighting** or **Manual Lighting**.

The fill light function is set at Intelligent Lighting as factory default. When video streaming is on, the fill light will be on automatically.

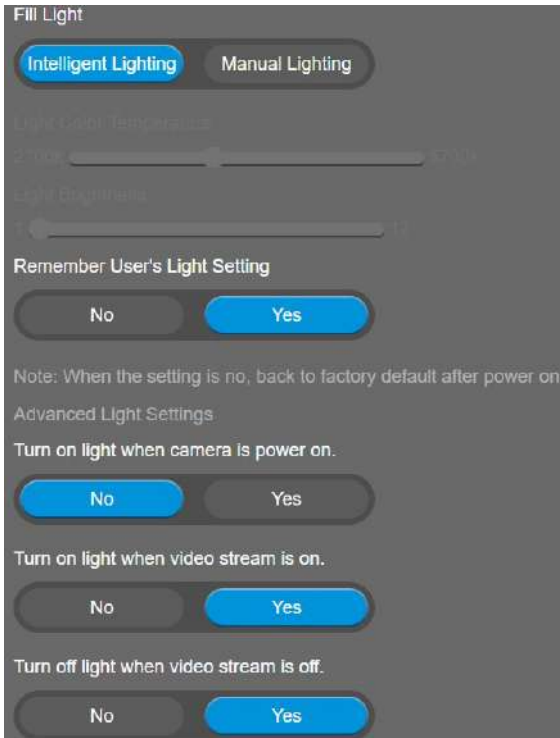

Image Settings

Field of View

Two kinds of view angle to select for different types of rooms.

Select **Setting > Image > Field Of View > Depth Room (90 degree)** or **Wide Room (120 degree)**.

[Note] To enable this option, please switch OFF all the AI functions.



Image Flip

If the VB130 is installed in the upside down position, please enable the "Flip".

Select **Setting > Image > Image Flip > Off** or **On**.



Image Mirror

To mirror the camera image.

Select **Setting > Image > Image Mirror > Off** or **On**.



True WDR

In back light environment, enable WDR to improve the brightness of image.

Select **Setting > Image > True WDR > Off** or **On**.

The frame rate will be limited to 30FPS while WDR is on.

If user enables this function in a normal light condition, the image will become over exposure and encounter image blur.

When WDR is enabled, camera has taken long exposure and user cannot manually adjust the brightness of image.



Frequency

Select the frequency of the camera.

Select **Setting > Image > Frequency > Off, 50 HZ or 60 HZ.**

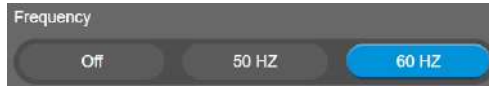

White Balance

Select the White Balance setting for various light conditions or color temperature.

Select **Setting > Image > White Balance > Auto or Manual.**

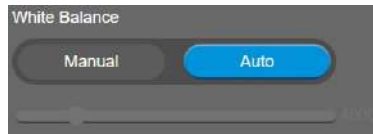

Noise Reduction

To reduce the noise from the signal.

Select **Setting > Image > Noise Reduction > Off, Low, Middle or High.**



Brightness

Adjust the value of brightness.

Select **Setting > Image > Brightness > 1 ~ 9.**



Sharpness

Adjust the value of sharpness.

Select **Setting > Image > Sharpness > Off, Low, Middle, or High.**



Saturation

Adjust the value of saturation.

Select **Setting > Image > Saturation > 1 ~ 9.**



Low Light Compensation

Enable/disable the compensation in low light environment.

Select **Setting > Image > Low Light Compensation > Off** or **On**.

Please notice that the frame rate will drop to 10~15 fps.

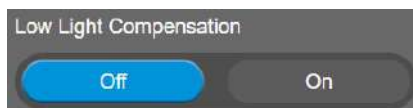

Video Format Settings

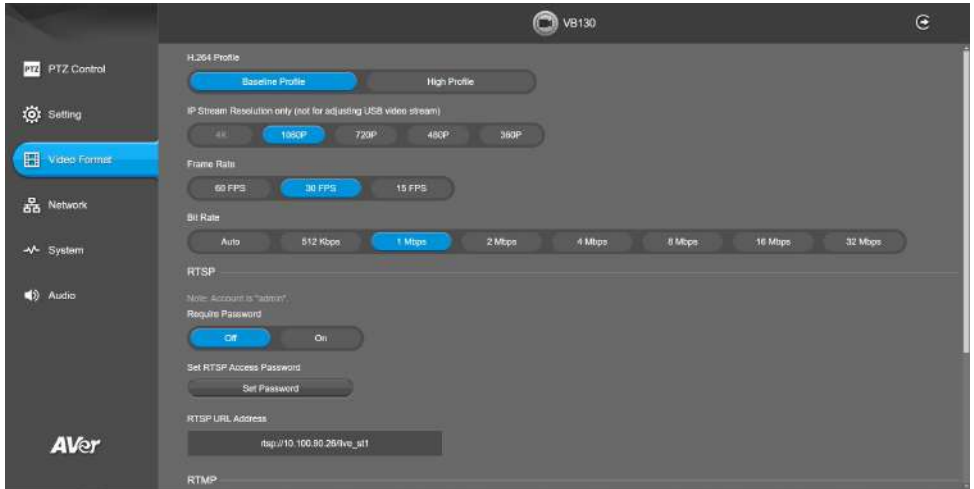

H.264 Profile

While in live broadcasting, user can choose preferable profile to get best streaming quality.

Select **Video Format > H.264 Profile > Baseline Profile** or **High Profile**.

[Note] RTSP, RTMP will not be available while USB streaming is in use.



IP Stream Resolution

Set up the resolution for IP stream. Not supported for USB video stream.

Select **Video Format > IP Stream Resolution only (not for adjusting USB video stream) > 1080P, 720P, 480P, or 360P**.

[Note] RTSP, RTMP will not be available while USB streaming is in use.



Frame Rate

Set up the frame rate value.

Select **Video Format > Frame Rate > 60 FPS, 30 FPS, or 15 FPS**.

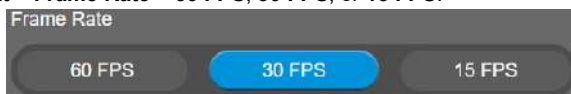

Bit Rate

Set up the bit rate value.

Select **Video Format > Bit Rate > Auto, 512 Kbps, 1 Mbps, 2 Mbps, 4 Mbps, 8Mbps, 16Mbps, or 32 Mbps.**

For Facebook live broadcasting, it's suggested to choose less than 4Mbps to ensure smooth streaming.



RTSP

To use RTSP player connecting to the camera, please enter the RTSP URL which displays on the web in your application such as VLC, PotPlayer or Quick Time.

Select **On/Off** to enable/disable password requirement while opening RTSP.



Set RTSP Password

1. Select **Video Format > RTSP > Set RTSP Access Password > Set Password.**
2. Enter the new password.
3. Select **Change** to save the new password.



RTMP

Set up for uploading the camera's live view to the broadcasting platform (e.g. YouTube).

Select **Video Format > RTMP**.

1. Locate the RTMP server URL and stream key from the broadcasting platform and enter in **Server URL** and **Stream Key** fields.
2. Select **Start** to begin uploading the live video of the camera to the broadcasting platform.
3. Select **Stop** to stop uploading the video.

Note: Due to Facebook limitation, to ensure video quality, please set maximum Bitrate at 4Mbps.

Server URL

Stream Key

Start Using RTMP

Start

Network Settings

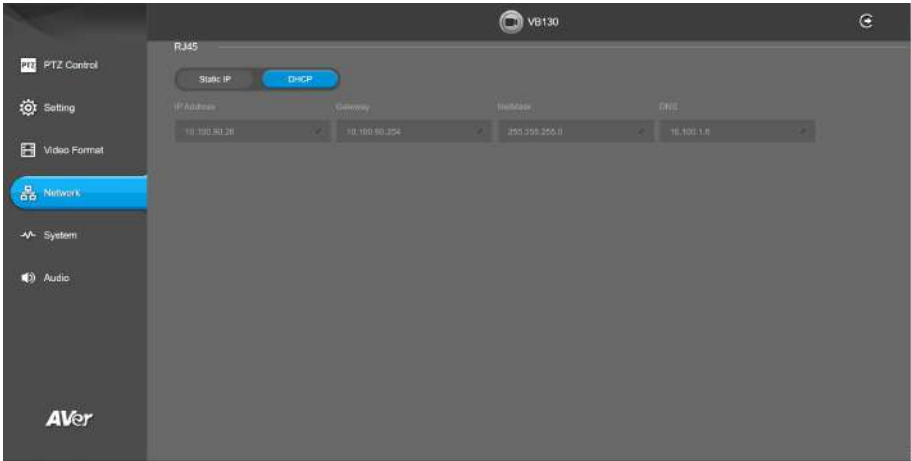

RJ45

Select **Network** > **RJ45** > **Static IP** or **DHCP**.



■ **Static IP:** Assign a fixed IP address to the camera.

1. Select pencil icon and enter **IP Address**, **Gateway**, **NetMask**, and **DNS** in the corresponding fields.
2. Select **Confirm** to complete the setting.

IP Address	Gateway	NetMask	DNS
10.100.90.26	10.100.90.254	255.255.255.0	10.100.1.6



IP Address	Gateway	NetMask	DNS												
10	100	90	26	10	100	90	254	255	255	255	0	10	100	1	6

Confirm

■ **DHCP:** Enable DHCP function.

System Settings

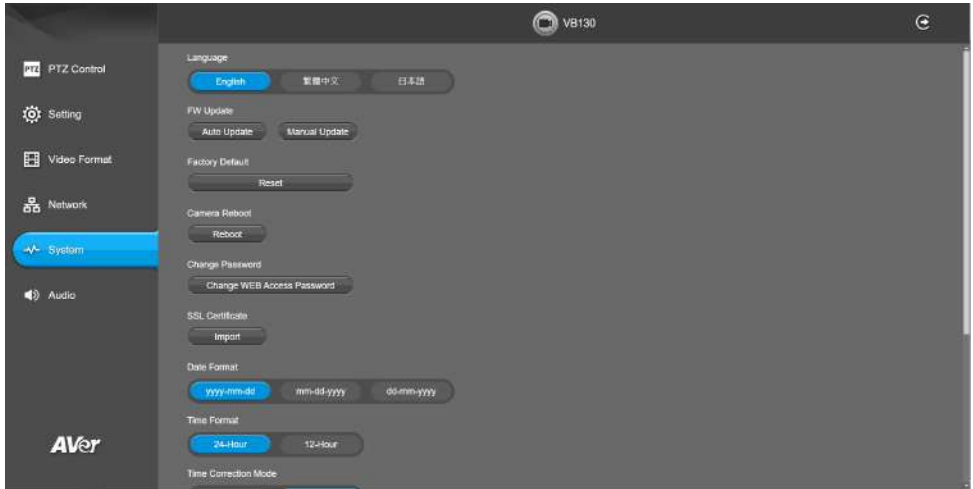

Language

Select the language of the system.

Select **System > Language > English, Traditional Chinese, or Japanese.**



Firmware Update

Update the camera's firmware.

Select **System > FW Update > Auto Update or Manual Update.**



- **Auto Update:** The system will check firmware version from AVer server and request to update.
- **Manual Update:** To update the firmware from specific location.

After updating, the camera will **reboot** and the connection will be lost. Please wait for few minutes and always keep the power cable connected. If unplugging the power during this process, it will cause damage of the device.

Factory Default

Reset the camera back to factory default setting.

1. Select **System > Factory Default > Reset**.
2. User can choose to keep current IP address or back to default.
3. Select **Continue** to reset back to factory default.

[Note] When factory default is activated, the password of web page login will not be set to default. For security concerns, to reset password of web page access, please download PTZApp 2 to reset it.



Camera Reboot

Restart the camera manually.

1. Select **System > Camera Reboot > Reboot**.
2. Select **Continue** to reboot the camera.



Change Password

Change the Web login password. The default password is “**aver4321**”.

1. Select **System > Change Password > Change WEB Access Password**.
2. Enter the old account and password. Select **Continue**.
3. Enter the new account and password. Select **Continue** to save the new setting.
4. If users forget the password and want to revert back to the default password, please use PTZApp 2 to reset it.

The image illustrates the steps to change the web access password through a series of three screenshots:

- Step 1:** A menu titled "Change Password" with a button labeled "Change WEB Access Password".
- Step 2:** A form titled "Change Password" with the instruction "Please enter old name & password for change." It contains two input fields: "Name" and "Password". Buttons for "Cancel" and "Continue" are visible on the right.
- Step 3:** A form titled "Change Password" with the instruction "Please change new name & password for login". It contains two input fields: "Name (6-10 alphabets or numbers)" and "Password (6-10 alphabets or numbers)". Buttons for "Cancel" and "Continue" are visible on the right.

SSL Certificate

Import the SSL certificate from specific location.

1. Select **System > SSL Certificate > Import**.
2. Select the type by clicking “+”.
3. Direct the file location.
4. Select **Import**.

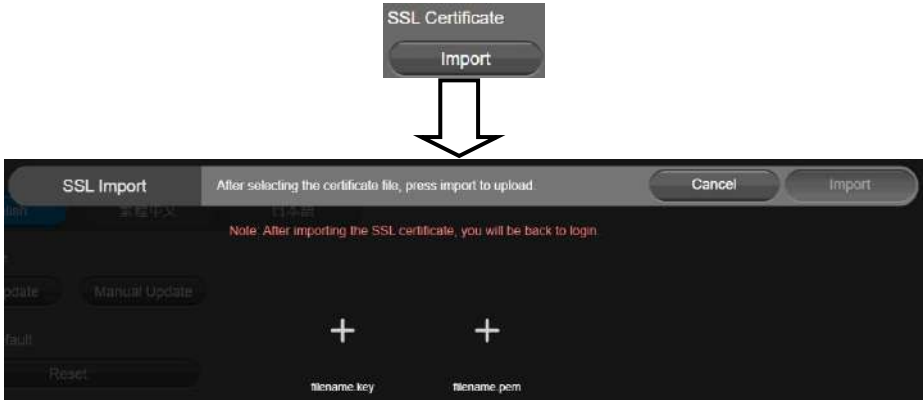

Date Format

Select the date format.

Select **System > Date Format > yyyy-mm-dd, mm-dd-yyyy, or dd-mm-yyyy**.



Time Format

Set up the time format.

Select **System > Time Format > 24-Hour or 12-Hour**.



Time Correction Mode

Adjust time by auto or manual.

Select **System > Time Correction Mode > Auto** or **Manual**.

- **Auto:** The system time will be set by NTP server on the network. Select the pencil icon of NTP Server and enter the URL of NTP server. Select the **Time Zone**. Select **NTP Update** to save setting. Select **Confirm** to start auto time adjustment.

[Note] Our default NTP server is located in the USA. If this does not work in your country, please manually key in the desired NTP server.

The screenshot shows the 'Time Correction Mode' interface. At the top, there are two buttons: 'Auto' (highlighted in blue) and 'Manual'. Below these are three columns: 'NTP Server' with the value 'pool.ntp.org' and a pencil icon, 'Time Zone' with a dropdown menu showing 'UTC-12:00', and 'NTP Update' with the text 'Update Completed'. At the bottom, there is a 'Time' field displaying '2021/4/29 17:42'.



This screenshot shows the same 'Time Correction Mode' interface. The 'NTP Update' button now says 'Disconnect'. A 'Confirm' button has appeared at the bottom left of the screen.

- **Manual:** User can set up time manually. Select the pencil icon and enter the **Year, Month, Day, Hour, and Minute**. Select **Confirm** to save the settings.

The screenshot shows the 'Time Correction Mode' interface with 'Manual' selected. The 'Time' field now displays '2021/4/29 19:01' and has a pencil icon to its right.



This screenshot shows a detailed time input screen. It has two sections: 'Year / Month / Day' and 'Hour : Minute'. Each section contains input fields for the respective values: 2021, 04, 29, 19, and 01. A 'Confirm' button is at the bottom.

Information

Display the information of **Model Name**, **Firmware Version**, **Serial Number**, **IP Address**, and **MAC Address**.

Select **System > Information**.

Model Name	Firmware Version	Serial Number
VB130	0.0.7300.50	1234567890123
IP Address	MAC Address	
10.100.90.26	36-69-88-00:00:08	

Audio Settings

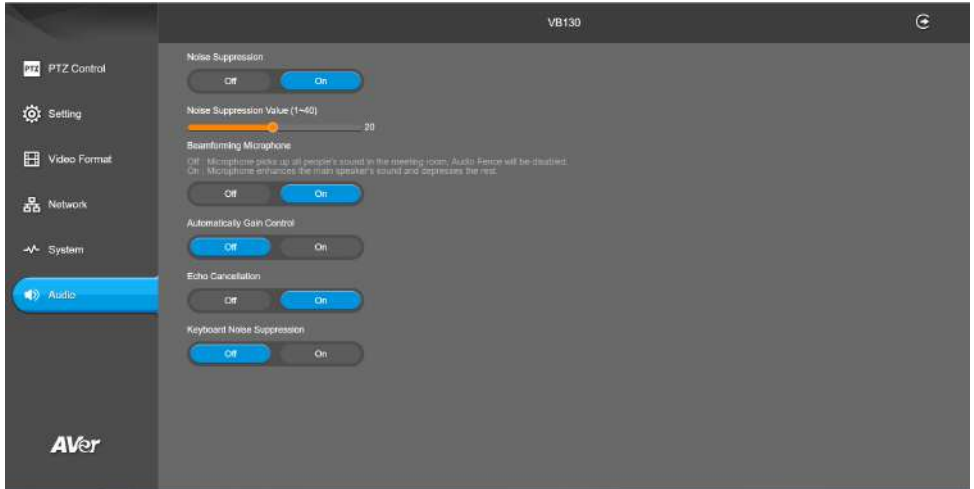

Noise Suppression

It is to reduce ambient noise.

Select **Audio > Noise Suppression > Off or On.**

When enabling the noise suppression function, please set value of noise suppression (1 ~ 40).



Beamforming Microphone

Enable/disable the beamforming microphone.

Select **Audio > Beamforming Microphone > Off or On.**

- **Off:** Microphone picks up all people's sound in the meeting room, Audio Fence will be disabled.
- **On:** Microphone enhances the main speaker's sound and depresses the rest.

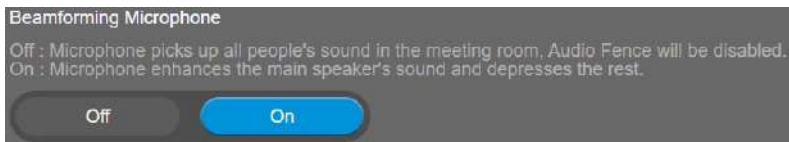

Automatically Gain Control

Enable/disable the auto gain control. It is to control ambient sound level and maintain a suitable output, despite variation of the one at the input.

Select **Audio > Automatically Gain Control > Off or On.**



Echo Cancellation

Enable/disable echo situation.

Select **Audio > Echo Cancellation > Off or On.**



Keyboard Noise Suppression

Enable/disable keyboard noise reduction.

Select **Audio > Keyboard Noise Suppression > Off or On.**



PTZApp 2

In PTZApp 2, user can change the IP address setting of VB130, configure the parameters of the camera, set up AI tracking functions and some advanced image and audio settings, pan, tilt, and zoom the camera.

Install PTZApp 2

Please go to <https://www.aver.com/download-center> (Global Headquarters), <https://www.aver europe.com/download-center> (European Headquarters), or <https://www.averusa.com/business/support/> (USA) to download the PTZApp 2. After downloading, double-click on the file and follow the on-screen instructions to complete the installation. After installing the PTZApp 2, double-click on the PTZApp 2 icon to run the application.

Use PTZApp 2 with USB Devices

1. Run your video application and make a video call.
2. During your video call, you can use the PTZApp 2 to pan, tilt and zoom the camera in/out and enable/disable the true WDR, brightness, and sharpness feature.
3. Launch PTZApp 2 () and it will open in Chrome browser automatically.

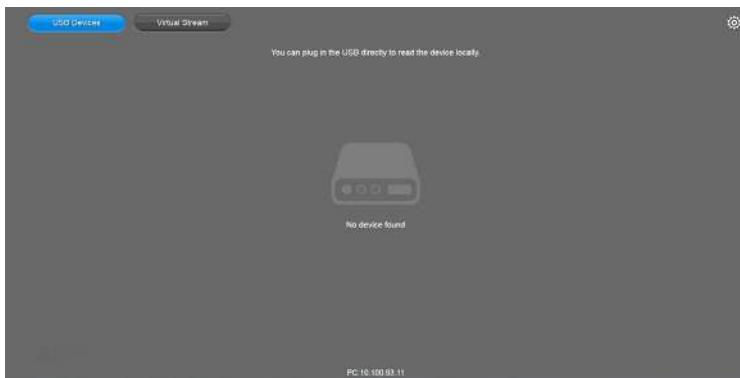

4. Choose "USB devices" and connect VB130 to PC/laptop with USB cable. When the camera is detected, the product card will show up.



5. Set up IP address. The camera default IP address is 192.168.1.168. Click pencil icon (✎) to edit IP address.

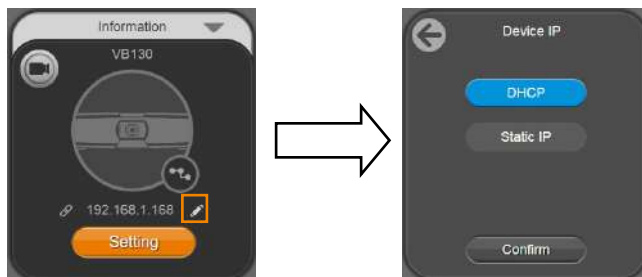

6. Click the setting icon to change Language, Hotkey Control, and PTZApp 2 Version.



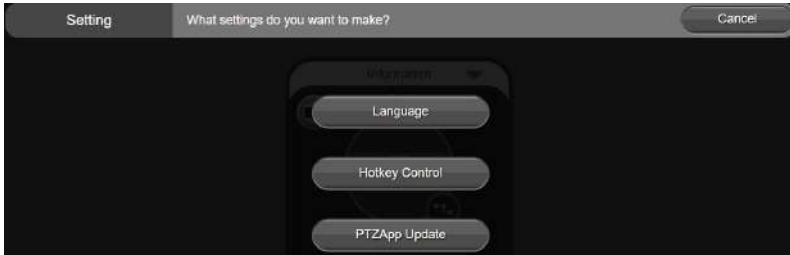

- **Language:** Select desired language and click the check icon to confirm the selection.



- **Hotkey Control:** User can control the camera by using keyboard. This is a general list for all Aver USB Cameras. Backlight control equals to WDR function in VB130



- **PTZApp Update:** Get current PTZApp 2's version number and do auto update here.







7. **Information:** Click the drop-down triangle icon to review the information of camera. To minimize the information, click the triangle or the bottom area of the information icon.

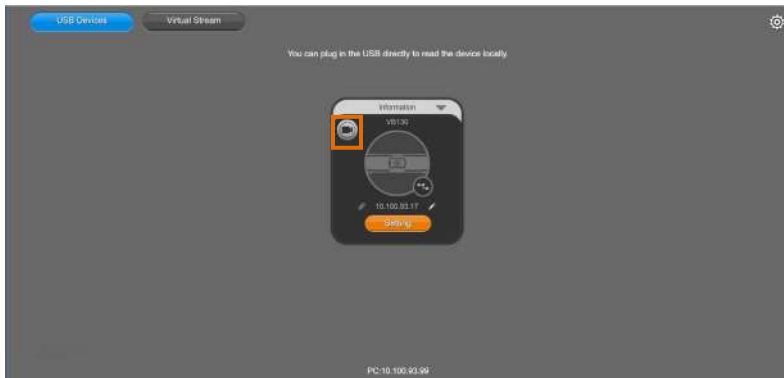

8. **Camera:** Click the camera icon to view the camera live view. IP address is displayed as well. Click the X icon to close the camera live view. If the live video did not appear, please check the camera and the laptop/PC connection to make sure all are correct and well connected.

The resolution of this small live view is 640x480 resolutions.



- **Full Screen:** PTZApp 2 can switch to full screen mode. Click “ ” icon and video screen will switch to full screen mode. In full screen mode, user can use direction panel to control camera direction. Click “ ” icon to go back to normal screen view. The resolution of full screen mode is 1080p/ 30fps.

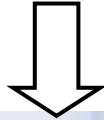
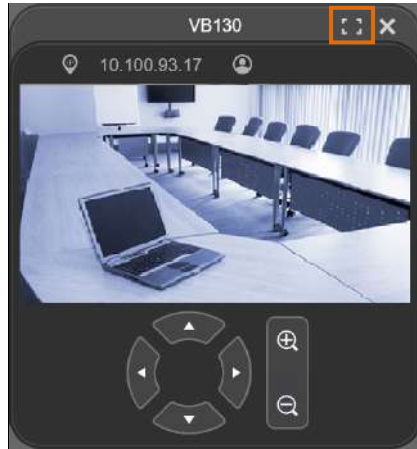

- **People Count and Stream Interval:** Click the  icon to show people count number and USB stream interval. Click the  or  icon to hide the stream interval.

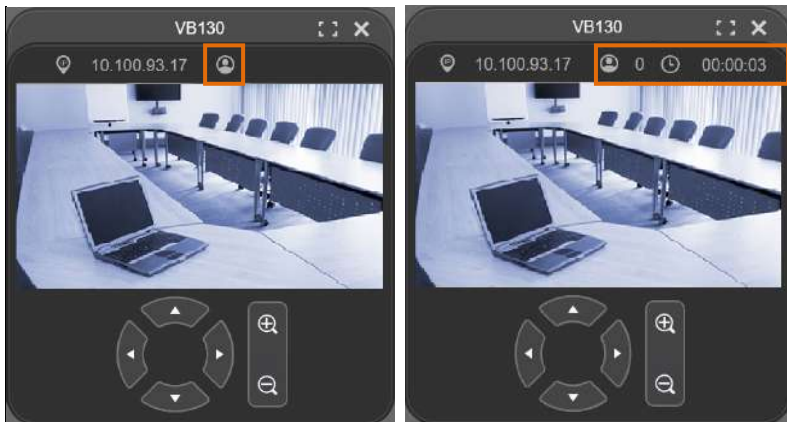

- **Control Panel:** To control the camera direction, zoom in and out during your video call.



9. **Setting:** Click “**Setting**” button to set up parameters of the camera and speakerphone. Click arrow icon to leave the Setting page.

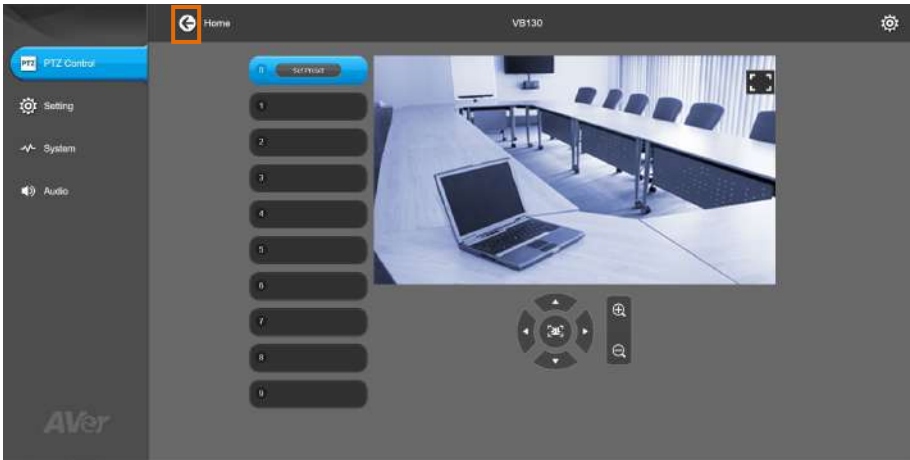
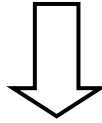

- **PTZ Control:** Use control panel to set up preset positions. Since most of operations are the same as web page, refer to [Set up the Preset](#) section (page 20) for detailed setup.
- **Setting:** To set up parameters of the camera. Since most of operations are the same as web page, refer to [Camera Settings](#) and [Image Settings](#) section (pages 21~28) for detailed setup.
- **System:** To setup system. Since most of operations are the same as web page, refer to [System Settings](#) section (pages 33~38) for detailed setup.
- **Audio:** To setup audio parameters. Since most of operations are the same as web page, refer to [Audio Settings](#) section (pages 39~40) for detailed setup.

The following items are different from web page in System.

- **I/O Port:** Except USB port, user can enable or disable all I/O ports.



- **BT Pairing:** Click **Start** to pair VB130 with mobile phone via Bluetooth connection. To disconnect Bluetooth connection, please cut it off from mobile phone or use remote control.



- **Trouble Shooting:** Click **Start** and **Output** to output log to save in local PC.



- **Test Speakerphone:** Click **Start** and **Start** to check the speakerphone status. It will require user to record a short message and play it back to ensure the speakerphone is working.



10. **PTZApp 2 Quit & Restore:** To quit the application, right-click the icon on the system tray and select **Quit**. If you can't launch PTZApp 2 right after installation, please right-click the icon and choose **Restore**.

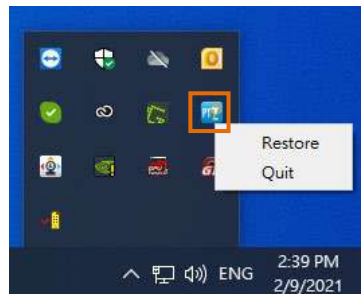

EZLive

Please go to <https://www.aver.com/download-center> to download the AVer EZLive software. After downloading, double-click on the file and follow the on-screen instructions to complete the installation.

Use AVer EZLive

During a video call, EZLive can help user to do:

- (1) Camera ePTZ
- (2) Volume control for the speaker connected
- (3) Capture camera's still images
- (4) Record video
- (5) Live stream to YouTube, Livehouse.in, USTREAM, etc.
- (6) Camera Zoom in/out
- (7) Capture PC screen shot
- (8) Record PC screen video
- (9) Set up livestream
- (10) Open file management to retrieve photos and video files
- (11) Livestream setting
- (12) Drawing tool.

